

INSTRUCTION MANUAL

CROSS NEEDLE SWR & POWER METER



CN-801 Series **HP** TYPE. **V** TYPE. **G** TYPE

The CN-801 Series is high quality Instrument with unique features which make tedious measurement of SWR and Power during antenna tests, matching and tuning of transmitters a very easy task. SWR and Power indicators are installed in one meter unit. One scale will indicate Forward Power. Another scale Reflected Power and SWR is indicated at the crossing point of the 2 needles. This unique feature makes it possible to read Forward Power, Reflected Power and SWR all at the same time. **HP Type** can also measure P.E.P.(Peak Power in SSB operation.)

■ SPECIFICATIONS

	HP Type	V Type	G Type
Frequency	※1.8~200 MHz	140~525 MHz	900~1300MHz
Power range : Forward	20/200/2KW	20/200W	2/20W
Tolerance	± 10% at full scale		
SWR measurement	1 : 1 ~ 1 : ∞		
SWR detection sensitivity	5W min		0.4W
Input / Output impedance	50 ohms		
Input / Output connectors	M Type (so - 239)	M or N Type	N Type
DC Power supply	※ DC13.8V (70mA)		
Dimensions and weight	157(W) X 117(H) X 117(D) mm, Approx		1Kg

※ Add 15% of full scale at 160-200MHz. Power Rating MAX 1kw(144MHz)

※ **HP type : DC Power(13.8V) is necessary to operate.**

■ CONTROLES AND FUNCTIONS

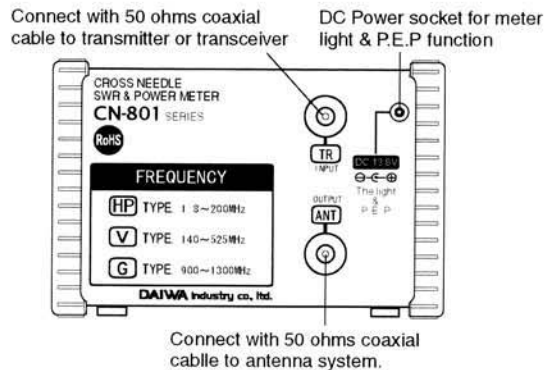
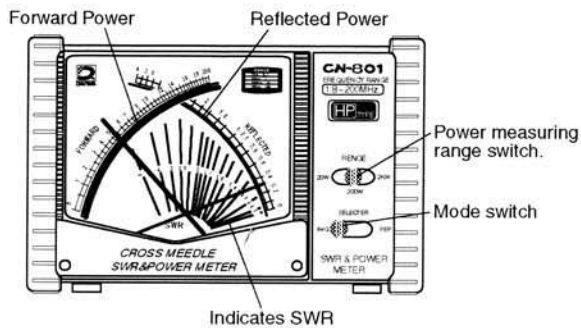

■ OPERATION

1. Use only 50 ohms coaxial line fo connections. This will maintain the accuracy of the meter.
2. For accurate power measurements, use 50 ohms pure resistance dummy load.(Fig.1)

※ **HP type : DC Power(13.8V) is necessary to operate.**

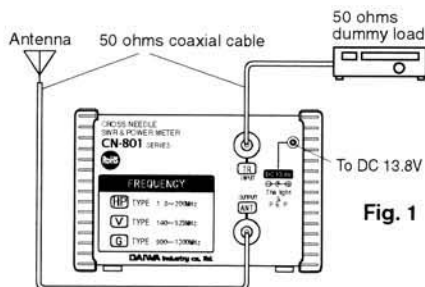

Fig. 1

3. Effective Radiated Power & SWR.

Select the Mode switch to 「AVG」 position.

To measure effective radiated power, subtract reflected power from Forward Power. (Apparent loss is only produced by impedance mismatch and does not include cables losses.)

See Fig.2. The meter indicates Forward power 10W and Reflected power 0.4W. At the crossing point of the 2 needles the indication is SWR1.5.

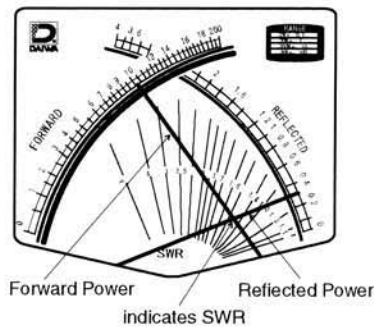

4. P.E.P power (Turn Mode switch to 「P.E.P」 position.)

HP type can also measure P.E.P Peak Power in SSB operation. (can not measure Reflected Power range.)

V, G type

When the transmitter is operated and the switch is in the 「P.E.P」 position the meter needle Monitor P.E.P of the SSB signal. This function can not hold peak envelope power.





Mathematical verification

$$SWR = \frac{\sqrt{P_f} + \sqrt{P_r}}{\sqrt{P_f} - \sqrt{P_r}} = \frac{\sqrt{10} + \sqrt{0.4}}{\sqrt{10} - \sqrt{0.4}} = 1.5$$

Pf : Forward Power Pr : Reflected Power

RF POWER FOR VARIOUS MODULATION MODES

(VOLTAGES SHOWN VARIOUS VOLTAGES FOR 50 OHMS DUMMY LOAD)

MODULATION MODE		Carrier Power (W)	Average Power (W)	PEP (W)
AM/FM CARRIER		100V	100	100
AM Single Tone (100% modulation)		200V	100	400
SSB Single Tone Modulation		100V	—	100
SSB Two Tone Modulation		100V	50	100
SSB Voice Modulation		100V	20~50	100

During the various SSB transmission modes, as shown in the table left, the meter reading of AVG and P.E.P will differ. Therefore, when in the SSB transmit mode, before switching the mode switch from AVG to P.E.P, make certain that the meter power setting is correct. Otherwise, the meter needle will go off-scale, resulting in damage to the instrument.

CAUTION

1. As the meter movements has high sensitivity, it should be handled with utmost attention. Prevent mechanical shock and vibration.
2. Measuring power with a poorly matched antenna or disconnecting the out put of the bridge while operating may damage the meter.
3. In low humidity conditions, the needles may stop on its way or may behave as though it caught on the meter face due to static electricity. In such case, apply commercially available static cream or spray for plastics or clothes on the meter face. The needles return to the original position.
4. Use only 50 ohms coaxial cable for connections. This will maintain the accuracy of the meter.